

Ø 64

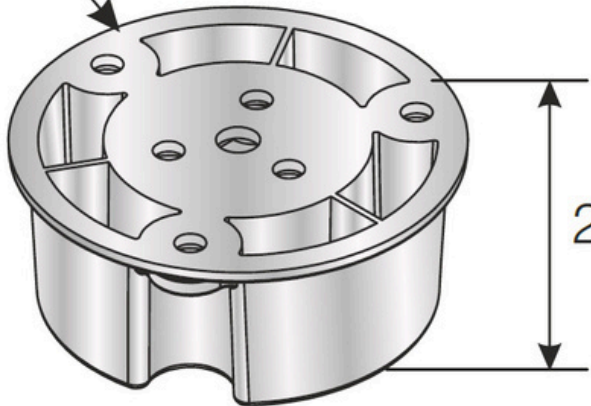

26